

ORDER INFORMATION

Specification:

1. Rating : DC 12V 1A;
2. Contact resistance: $\leq 30m\Omega$;
After test: $\leq 50m\Omega$
3. Insulation resistance: $\geq 100M\Omega$ (500VDC);
After test: $\geq 50M\Omega$
4. Withstanding voltage: 500VAC ;
5. Insertion and extraction force: 3N~30N;
6. life test: 5000cycles min;
7. Operation temperature range: $-20^{\circ}C \sim 70^{\circ}C$
8. Preservative temperature range: $-40^{\circ}C \sim 85^{\circ}C$

5 D J X X M C 2 6 - X X S V B U X - 0 1

PIN (Dim.A)
10: $\phi 1.0$
13: $\phi 1.3$

No. of Pin(02-03)	SV: Silver plated	B: Black	RoHS	B: Bag H:T/R W/O Cap
-------------------	-------------------	----------	------	-------------------------

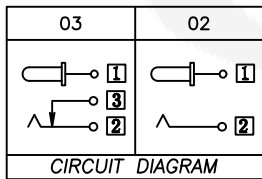
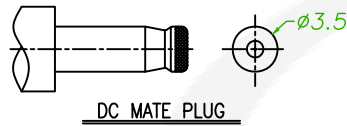

□ : TERMINAL NO.

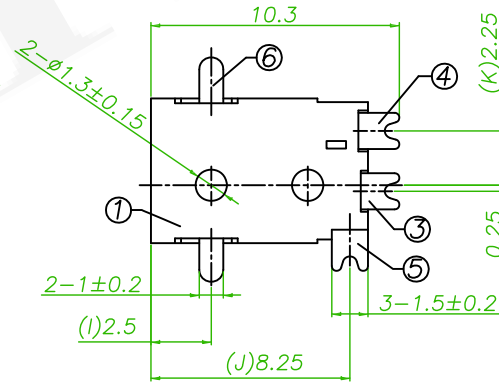
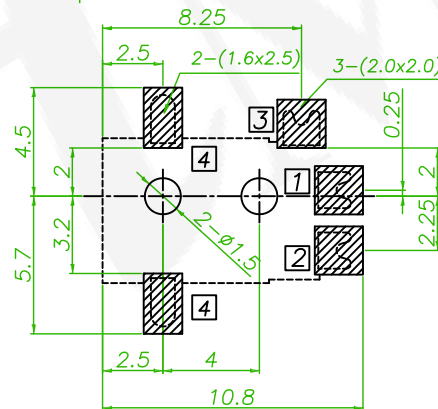
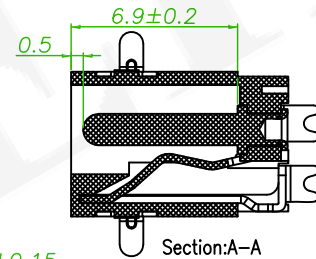
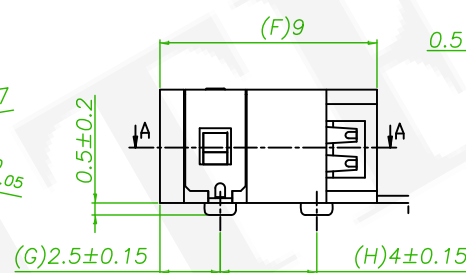
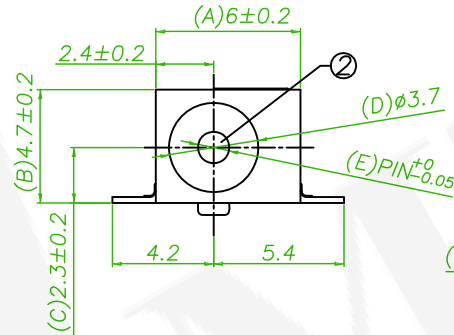

Recommended PCB Layout
(PCB TOLERANCE ± 0.05)



⑥ Shield plate	1	Brass t0.2	Silver plating
⑤ Shunt terminal	1	Brass t0.25	Silver plating
④ Tip spring	1	Beryllium bronze t0.3	Silver plating
③ Center pin terminal	1	Brass t0.2	Silver plating
② Center pin	1	Brass	Nickel plating
① Housing	1	LCP	Black
NO.	DESCRIPTION	QTY	MATERIAL PLATING

Old Part No. : DCJXX-0045BSVB-U

REV.	ECN NO. OR DESCRIPTION	REVISED	DATE
Bx2	Add: H: T/R W/O Cap	David	2019/06/17

 糧德精密有限公司 Amtek Technology Co., Ltd. TEL: 886-2-2260-6878 FAX: 886-2-2260-8030	品名 TITLE	DC POWER JACK				頁數 Page	1/1
	品號 PART NO.	5DJXXMC26-XXSVBUX-01		繪圖 DRAWN	Erin		2015/10/07
	圖號 DRAWING NO.	GN013-DV127		版本 REV.	B	核對 CHECKED	John
	客戶品號 CUSTOMER P/N			比例 SCALE	None	承認 APPROVED	John
	公差 TOLERANCE	.X±0.30 .XX±0.20	.X°±2	單位 UNIT	mm	THIRD ANGLE PROJECTION	